

ICOM<sup>®</sup>

INSTRUCTION MANUAL

UHF TRANSCEIVER

**IC-400PRO**



Icom Inc.

---

## IMPORTANT

---

**READ ALL INSTRUCTIONS** carefully and completely before using the transceiver.

**SAVE THIS INSTRUCTION MANUAL** — This instruction manual contains important operating instructions for the **IC-400PRO UHF TRANSCEIVER**.

---

## EXPLICIT DEFINITIONS

---

WORD	DEFINITION
<b>⚠ WARNING</b>	Personal injury, fire hazard or electric shock may occur.
<b>CAUTION</b>	Equipment damage may occur.
<b>NOTE</b>	If disregarded, inconvenience only. No risk of personal injury, fire or electric shock.

Icom, Icom Inc. and the ICOM logo are registered trademarks of Icom Incorporated (Japan) in the United States, the United Kingdom, Germany, France, Spain, Russia and/or other countries.

---

## PRECAUTION

---

**⚠ WARNING! NEVER** connect the transceiver to an AC outlet. This may pose a fire hazard or result in an electric shock.

**⚠ WARNING! NEVER** operate the transceiver while driving a vehicle. Safe driving requires your full attention—anything less may result in an accident.

**NEVER** connect the transceiver to a power source of more than 16 V DC. This will damage the transceiver.

**NEVER** cut the DC power cable between the DC plug and fuse holder. If an incorrect connection is made after cutting, the transceiver might be damaged.

**NEVER** place the transceiver where normal operation of the vehicle may be hindered or where it could cause bodily injury.

**NEVER** allow children to play with any radio equipment containing a transmitter.

**NEVER** expose the transceiver to rain, snow or any liquids. The transceiver may be damaged.

**NEVER** operate or touch the transceiver with wet hands. This may result in an electric shock or damage the transceiver.

---

**DO NOT** push the PTT when not actually desiring to transmit.

**DO NOT** use or place the transceiver in areas with temperatures below  $-10^{\circ}\text{C}$  or above  $+60^{\circ}\text{C}$ , or in areas subject to direct sunlight, such as the dashboard.

**AVOID** operating the transceiver without running the vehicle's engine. When the transceiver's power is ON and your vehicle's engine is OFF, the vehicle's battery will soon become exhausted.

**AVOID** placing the transceiver in excessively dusty environments.

**AVOID** placing the transceiver against walls. This will obstruct heat dissipation.

**AVOID** setting the transceiver in a place without adequate ventilation. Heat dissipation may be affected, and the transceiver may be damaged.

**AVOID** the use of chemical agents such as benzine or alcohol when cleaning, as they damage the transceiver surfaces.

**USE** the specified microphone only (supplied or optional). Other microphones have different pin assignments and may damage the transceiver.

**BE CAREFUL!** The transceiver will become hot when operating continuously for long periods.



**N33**

This device complies with Standard Australia Specification No. AS/NZS4365-1996 and AS4295-1995.

---

# TABLE OF CONTENTS

---

IMPORTANT .....	i	<b>7 OTHER FUNCTIONS .....</b>	<b>22–33</b>
EXPLICIT DEFINITIONS .....	i	■ Smart-Ring and ATS (Automatic Transponder System) .....	22
PRECAUTION .....	i	■ Voice scrambler function .....	23
TABLE OF CONTENTS .....	iii	■ DTMF transmission .....	24
SUPPLIED ACCESSORIES .....	iv	■ Channel lock function .....	24
<b>1 PANEL DESCRIPTION .....</b>	<b>1–4</b>	■ RX frequency setting .....	25
■ Front panel .....	1	■ Wide/Narrow function .....	26
■ Function display .....	4	■ Set mode .....	27
<b>2 BASIC OPERATION .....</b>	<b>5–6</b>	<b>8 PROGRAMMABLE FUNCTION KEYS .....</b>	<b>34–36</b>
■ Turning power ON .....	5	<b>9 CONNECTION AND MAINTENANCE .....</b>	<b>37–40</b>
■ Channel selection .....	5	■ Rear panel and connection .....	37
■ Receiving and transmitting .....	6	■ Mounting the transceiver .....	38
<b>3 REPEATER OPERATION .....</b>	<b>7</b>	■ Optional UT-108 installation .....	39
■ Repeater operation .....	7	■ Optional UT-109 or UT-110 installation .....	39
■ Accessing a repeater .....	7	■ Optional OPC-617 installation .....	40
<b>4 SCAN OPERATION .....</b>	<b>8–14</b>	■ Antenna .....	40
■ Scan types .....	8	■ Fuse replacement .....	40
■ Scanning preparation .....	9	■ Cleaning .....	40
■ Open scan .....	11	<b>10 SPECIFICATIONS .....</b>	<b>41</b>
■ Group and priority scans .....	12	<b>11 OPTIONS .....</b>	<b>42</b>
■ Repeater search scan .....	13		
<b>5 GROUP MODE OPERATION .....</b>	<b>15–16</b>		
■ Group mode (CTCSS) .....	15		
<b>6 SELCALL OPERATION .....</b>	<b>17–21</b>		
■ General .....	17		
■ Calling operation .....	17		
■ When receiving a call .....	20		
■ Setting the silent stand-by condition .....	21		

# SUPPLIED ACCESSORIES

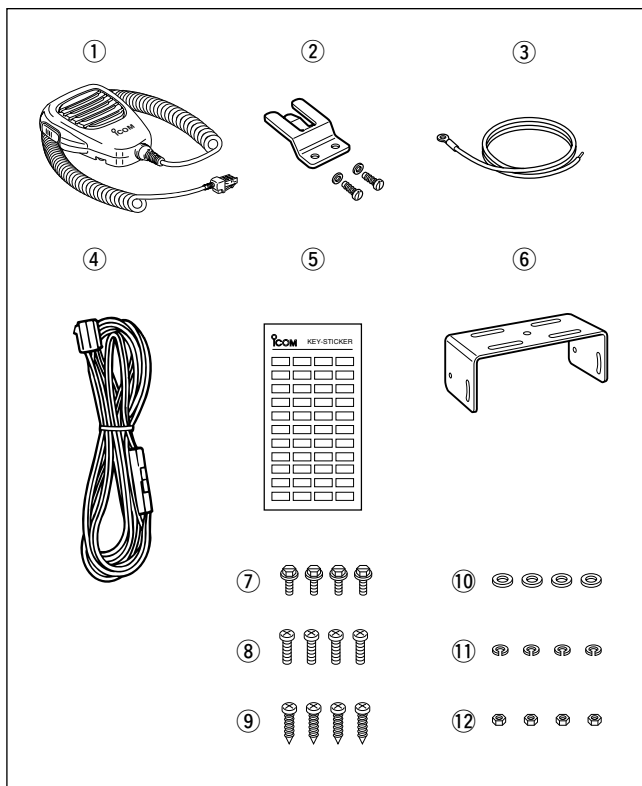

① Microphone .....	1
② Microphone hanger and screw set .....	1 set
③ Microphone hanger cable .....	1
④ DC power cable (OPC-1194) .....	1
⑤ Function name stickers* (KEY STICKER) .....	1
⑥ Mounting bracket .....	1
⑦ Bracket bolts .....	4
⑧ Mounting screws (M5×12) .....	4
⑨ Self-tapping screws (M5×20) .....	4
⑩ Flat washers .....	4
⑪ Spring washers .....	4
⑫ Nuts .....	4

## \*Function name stickers

Function of keys can be changed. Stickers are supplied for easy identification.

# 1

## PANEL DESCRIPTION

### ■ Front panel

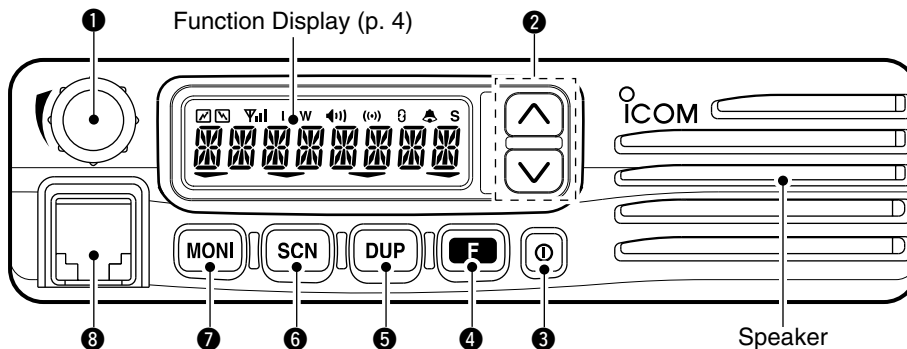

#### 1 AF VOLUME CONTROL KNOB

Rotate the knob to adjust the audio output level.

- Minimum audio level is pre-programmed.

#### 2 [▲]/[▼] KEYS\*

- Push to select an operating channel.
- After pushing [F], push to toggle between CB bank and Private bank (user programmable channels).

#### 3 POWER SWITCH [⏻]

Push to turn the power ON and OFF.

- The Automatic scan start function and the password prompt are available at power ON as optional settings. (The optional CS-400PRO CLONING SOFTWARE IS REQUIRED.)

#### 4 [F] KEY\*

- Push to enter channel bank selection mode.
  - In channel bank selection mode, push [▲]/[▼] to select the desired channel bank.
- Push for 1 sec. to toggle Function mode, Set mode or Normal mode.
  - Returns to the Normal mode automatically after 30 sec. when no key operations are performed in Function or Set mode.

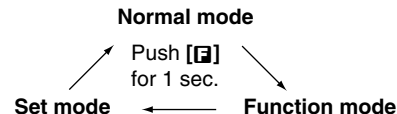

5 [DUP] KEY\*

- ➔ **[N]** Push to toggle the transmit frequency mode between duplex and simplex. (CB channel 1 to 8 only)
  - Duplex: The set TX frequency is used for the transmission.
  - Simplex: The set RX frequency is used for the transmission.
- ➔ **[N]** Push and hold to set the selected channel to priority or normal.
  - Priority channel is used for both group and priority scans.
- ➔ **[F]** Push to toggle the 5tone mute activity between CONT (Continuous Tone) and SGL (Single Tone).
  - CONT: SelCall mute is released.
  - SGL: SelCall mute is activated. In this case, [PTT] switch action is inhibited while SelCall mute is activated.

6 [SCN] KEY\*

- ➔ **[N]** Push to start or stop the scan.
- ➔ **[N]** Push and hold to enter the scan type selection mode.
  - Push [**^**]/[**∨**] to select the desired scan type.
  - Push [**SCN**] to set the channel as a tag channel.
    - “S” appears for tag channels.
- ➔ **[F]** Push to recall the received ID code.
  - Push [**^**]/[**∨**] to select the record.

➔ **[N]** : Stands for Normal mode operation.  
 ➔ **[F]** : Stands for Function mode operation.

7 [MONI] KEY\*

- ➔ **[N]** Activates the following functions on each channel independently:
  - Push and hold the key to release the mute to the channel (audio is emitted; ‘Audible’ condition).
    - “**◀▶**” appears.
  - During “**◀▶**” appears, push the key to mute the channel (sets to ‘Inaudible’).
- ▨ **NOTE:** The unmute condition (‘Audible’ condition) may automatically return to the mute condition (‘Inaudible’ condition) after a specified time period depending on the pre-setting.
- ➔ **[F]** Push to transmit the SelCall code on the selected channel.
- ➔ **[F]** Push and hold to enter the SelCall code/code number selection mode (p. 17).
  - Push [**^**]/[**∨**] to select the desired code/code number.

**\*Information**  
 Up to two desired functions, one each for Normal and Function mode, can be re-assigned to [**^**], [**∨**], [**F**], [**DUP**], [**SCN**] and [**MONI**] keys with the optional CS-400PRO CLONING SOFTWARE. (p. 34)  
 The default setting is used in this instruction manual, for description.

# 1 PANEL DESCRIPTION

## Key flow chart for the default setting

Push [⏻] to turn power ON.

### Normal mode

⏮: [CH Up]      SCN: [Scan Start/Stop]  
⏭: [CH Down]    DUP: [Dup/Pri]  
MONI: [Moni(Audi)]    F: [Bank/Func]

↓ Push [F] for 1 sec.

### Function mode

⏮: [CH Up]      SCN: [ID-MR Select]  
⏭: [CH Down]    DUP: [CONT/SGL]  
MONI: [Call]      F: [Bank/Func]

↓ Push [F] for 1 sec.

### Set mode

⏮/⏭: Set the desired level/mode.  
MONI: Change the individual setting.  
SCN: Change the common setting.  
DUP: Turn the function ON and OFF.  
F: Push to enter channel bank selection mode.  
Push for 1 sec. to enter Normal mode.

## 8 MICROPHONE CONNECTOR

Connect the supplied microphone or optional DTMF microphone.

**NEVER** connect non-specified microphones. The pin assignments may be different and the transceiver may be damaged.

## ◇ MICROPHONE

The supplied microphone has a PTT switch and a hanger hook.

- The following functions are available when the microphone is on or off hook:  
(The optional CS-400PRO CLONING SOFTWARE is required.)
  - Automatic scan start when on hook.
  - Automatic priority channel selection when off hook.
  - Sets to 'Inaudible' condition (mute condition) when on hook.
  - Sets to 'Audible' condition (unmute condition) when off hook.



## Function display

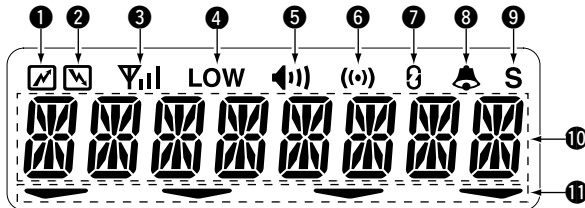

### 1 TRANSMIT INDICATOR

Appears while transmitting.

### 2 BUSY INDICATOR

Appears while receiving a signal or when the squelch is open.

### 3 SIGNAL STRENGTH METER

Indicates relative receive signal strength level.

### 4 LOW POWER INDICATOR

Appears when low output power is selected.

 [High/Low] must be assigned to the desired programmable key using the optional CS-400PRO CLONING SOFTWARE when change the output power.

### 5 SQUELCH INDICATOR

Appears when the channel is in 'Audible' condition (SelCall/CTCSS mute is released).

### 6 DUPLEX INDICATOR

Appears when the duplex operation is selected.

### 7 SCRAMBLER INDICATOR

Appears when the scrambler function is activated. (Optional UT-109 (#02)/UT-110 (#02) SCRAMBLER UNIT is required.)

### 8 SELCALL/5TONE INDICATOR

Appears when the specified Selcall/5-tone is received.

### 9 SCAN CHANNEL INDICATOR



Appears when the selected memory channel is specified as a scan channel.

### 10 ALPHANUMERIC DISPLAY

Displays the operating channel number, channel names, Set mode contents, DTMF numbers, etc.

### 11 UNDER BAR INDICATOR

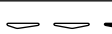
- ➔ Shows the channel mute condition ('Inaudible' condition) as below.
- ➔ The left under bar blinks in Function mode, and lights in Set mode.
- ➔ Appears in Set mode when the key under the indicator can be activated.

The channel is in CTCSS mute condition.	
The channel is in SelCall mute condition.	
The channel is in both CTCSS/SelCall mute condition.	

 During "◀" appears, the channel is 'Audible' condition even if the channel is in mute condition.

## ■ Turning power ON

➔ Push [⏻] to turn the power ON.

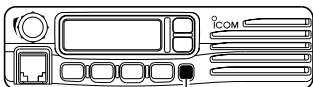

Push [⏻]

### **About the password prompt:**

If the transceiver is programmed for a start up passcode, enter the specified 4-digit code.

(The optional CS-400PRO CLONING SOFTWARE is required.)

PASSWORD

- The keys in the table below can be used for password input:
- The transceiver detects numbers in the same block as identical. Therefore “01234” and “56789” are the same.

KEY	MONI	SCN	DUP	F	⏻
NUMBER	0 5	1 6	2 7	3 8	4 9

When the “PASSWORD” indication does not clear after entering 4 digit code, the enter code number is incorrect. In this case, turn the power off and start over.

## ■ Channel selection

- ➔ Push [▲]/[▼] to select the desired operating channel.
  - While pushing and holding [▲] or [▼], the displayed channel changes continuously until channel number “01” appears.
  - When displayed channel stops at channel number “01”, beeps are emitted.

Push [▲] or [▼]

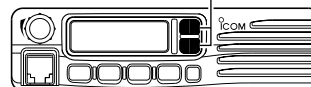

### ◇ Private channel selection

- ① Push [F] (Bank/Func) to enter the channel bank selection mode. Then select the desired bank with [▲]/[▼]. Push [F] (Bank/Func) again to set the bank.

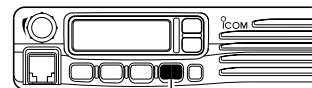

Push [F]

- ② Push [▲]/[▼] to select the desired operating channel in sequence.

**NOTE:** The selected channel is retained even when the transceiver is turned off.

## ■ Receiving and transmitting

### RECEIVING:

- ① Push [ **1** ] to turn the power ON.
- ② Select the desired operating channel. (p. 5)
- ③ While receiving a signal, adjust the audio output level to a comfortable listening level.

### TRANSMITTING:

- ① While pushing and holding [PTT], speak into the microphone at your normal voice level.
- ② Release [PTT] to receive.

**IMPORTANT!:** To maximize the readability of your signal;

- ➔ After pushing [PTT], pause briefly.
- ➔ Hold the microphone 2 to 5 cm from your mouth, then speak into the microphone at a normal voice level.

### ◇ Transmitting notes

#### • Time-out timer

After continuous transmission for a pre-programmed period, the time-out timer is activated causing the transceiver to stop transmitting and automatically select receive.

**NOTE:** Transmission is inhibited when the channel is in 5 tone mute condition ('Inaudible' condition), or receive only channel is selected.

# 3

## REPEATER OPERATION

### ■ Repeater operation

Repeaters allow you to extend the operational range of your radio.

Normally, a repeater has independent frequencies for receive and transmit.

#### Repeater example;

Receives the channel 31 signal and the detected audio signals are transmitted on channel 1 simultaneously.

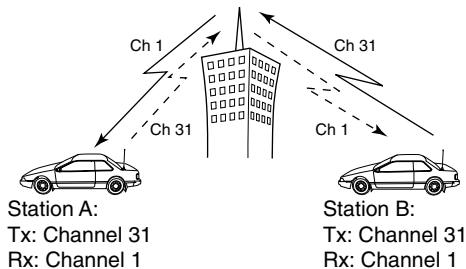

### ■ Accessing a repeater

A repeater amplifies received signals and re-transmits them on a different channel, allowing you to communicate over greater distances with improved reliability. When using a repeater, the transmit channel is shifted from the receive channel by 30 channels. You can search the accessible repeater in your local area using the Repeater search scan function (p. 13).

- ① Push [**^**]/[**v**] to select the desired channel from 1 to 8 (repeater output channel).
- ② Push [**DUP**] (Dup/Pri) to set duplex.
  - “(◦)” appears.
  - The duplex setting is only available on channels 1 to 8.
- ③ While pushing and holding [PTT], speak into the microphone at your normal voice level.
  - The displayed channel automatically changes to the transmit channel (repeater input channel), and “◻” appears.

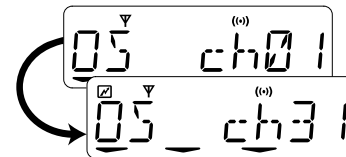

- ④ Release [PTT] to receive.
- ⑤ To cancel the duplex setting, push [**DUP**] (Dup/Pri).

## Scan types

The transceiver has 4 scan types, tag function and 4 resume conditions providing scanning versatility.

Tag channels are independently set for open, group and priority scans. Initially, all channels may be set as tag channels for all scans.

**IMPORTANT!:**  
A microphone should be on hook to start scanning.

3  
4

### OPEN SCAN

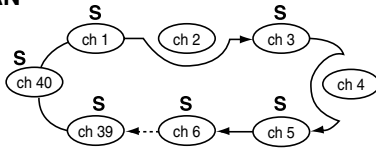

Repeatedly scans all tag channels in sequence.

### GROUP OR PRIORITY SCAN

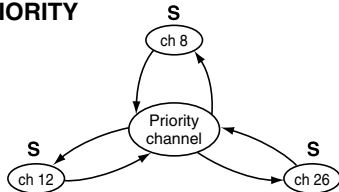

Repeatedly watches a priority channel while scanning only specified tag channels.

### REPEATER SEARCH SCAN

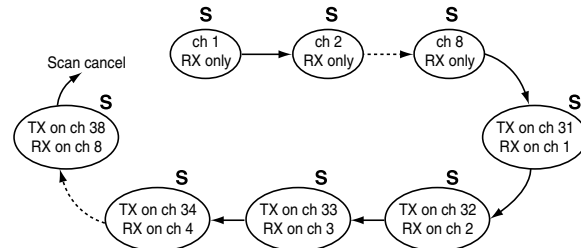

Scans all repeater channels (1 to 8) in sequence.

If there are no busy channels after scanning channels 1 to 8 (RX only), it begins scanning from channel 1 again, then the transceiver transmits a signal to search for a repeater while the scanning.

## 4 SCAN OPERATION

### ■ Scanning preparation

IC-400PRO scans all tagged channels, and can be selected so the scan resume condition is a pause or timer scan. Therefore, these items must be set before starting a scan (except the repeater search scan). These items must be set for each scan type (open, group and priority) independently.

#### ◇ Setting scan tag

- ① Select the desired channel. (p. 5)
- ② Push **[SCN]** (Scan Start/Stop) for 1 sec. to enter the scan type selection mode.

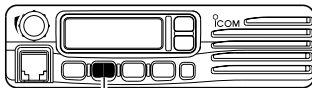

Push **[SCN]** for 1 sec.

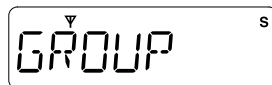

Previously selected scan type is displayed.

- ③ Push **[^]**/**[v]** to select the desired scan type.
  - Open, group, priority and repeater search scans are available.

Push **[^]** or **[v]**

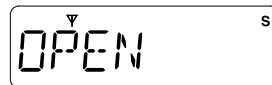
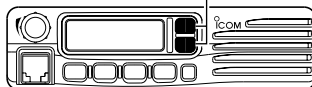

Open scan

- ④ Push **[SCN]** (Scan Start/Stop) to select the tag setting ON and OFF.

- "S" appears when the tag setting ON (The channel is set as a scan channel).

Push **[SCN]**  
(Scan Start/Stop)

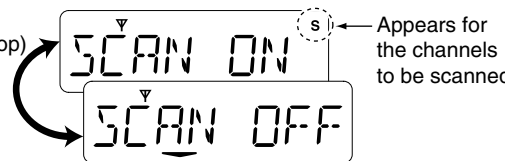

- ⑤ Push **[SCN]** (Scan Start/Stop) for 1 sec. to return to Normal mode.

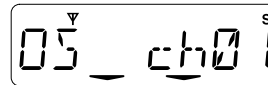

Open scan setting

#### ▨ To speed up scanning:

For open scan, cancel the tag channel setting to skip undesired channels such as usually busy channels.

For group scan, set only often-used channels as tag channels.

All memory channels may be set as tag channels by default.

◇ Setting scan resume condition

USING SET MODE

- ① Push [F] (Bank/Func) for 1 sec. to enter Function mode.
- ② Push [F] (Bank/Func) for 1 sec. again to enter Set mode.

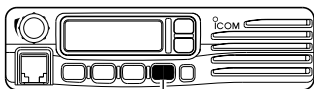

Push [F] for 1 sec.

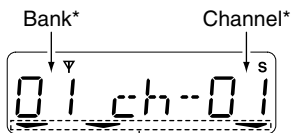

\*The bank and channel number are continuously displayed after entering set mode.

The keys under these indicators can be activated.

- ③ Push [SCN] for 1 sec. to enter the common setting for the transceiver.
- ④ Push [SCN] several times until "SST" appears.

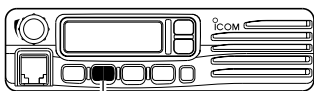

Push [SCN]



"SST" appears

- ⑤ Push [^]/[v] to select the desired scan resume condition.

- "T-5" : Scan pauses for 5 sec. then resumes.
- "T-10" : Scan pauses for 10 sec. then resumes.
- "T-15" : Scan pauses for 15 sec. then resumes.
- "P-5" : Scan pauses until the signal disappears, then resumes 5 sec. after the signal disappears.

• T-5 setting



• T-10 setting



• T-15 setting



• P-5 setting

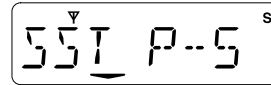

- ⑥ Push [SCN] for 1 sec., then push [F] for 1 sec. to return to Normal mode.

## 4 SCAN OPERATION

### ■ Open scan

Open scan searches for being transmitted signals automatically and makes it easier to locate new stations for contact or listening purposes.

#### IMPORTANT!:

- A microphone should be on hook to start scanning.
- During open scan, transmission is inhibited except on a busy channel.

- ① Push **[SCN]** (Scan Start/Stop) for 1 sec. to enter the scan type selection mode.

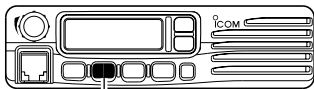

Push **[SCN]** for 1 sec.



Previously selected scan type is displayed.

- ② Push **[^]/[v]** to select the open scan.

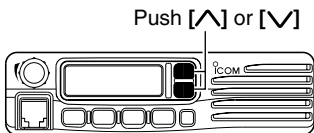

Push **[^]** or **[v]**

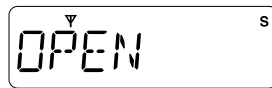

Open scan

- ③ Push **[SCN]** (Scan Start/Stop) for 1 sec. to return to Normal mode.

- "OS" appears besides the channel number indication.



Open scan setting

- ④ Push **[SCN]** (Scan Start/Stop) to start the open scan.

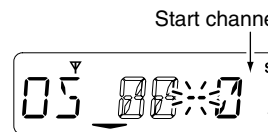

Start channel

- ⑤ When receiving a signal, scan pauses and resumes according to the selected scan resume condition. (p. 10)
- ⑥ Push **[SCN]** (Scan Start/Stop) to cancel the scan.



## ■ Group and priority scans

Group and priority scans repeatedly watch a priority channel while scanning specified channels. This is useful when waiting for a call on the priority channel or several specified channels.

Group and priority scans behave differently when transmitting. Group scan can only transmit on a busy channel, and priority scan can only transmit on a priority channel or start channel.

### /// IMPORTANT!:

A microphone should be on hook to start scanning.

- ① Push **[SCN]** (Scan Start/Stop) for 1 sec. to enter the scan type selection mode.
- ② Push **[▲]/[▼]** to select the group or priority scan.

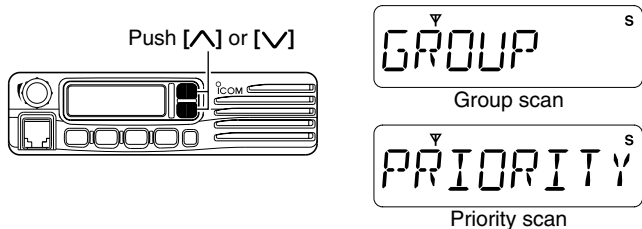

- ③ Push **[SCN]** (Scan Start/Stop) for 1 sec. to return to Normal mode.
  - “GS” or “PS” appears besides the channel number indication.

- ④ Select the priority channel if desired.
  - Push **[▲]/[▼]** to select the desired channel.
  - Push **[DUP]** (Dup/Pri) for 1 sec. to set the channel as a priority channel.

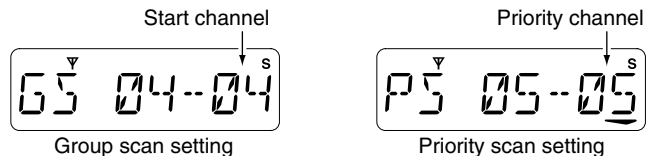

- ⑤ Push **[SCN]** (Scan Start/Stop) to start the scan.

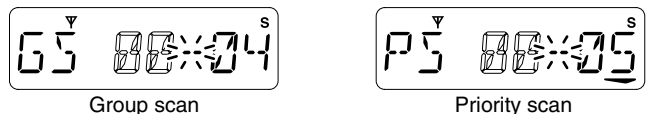

- ⑥ When receiving a signal, the scan pauses and resumes according to the selected scan resume condition. (p. 10)
- ⑦ Push **[SCN]** (Scan Start/Stop) to cancel the scan.

## 4 SCAN OPERATION

### ■ Repeater search scan

The repeater search scan is not only searching for a signal on the repeater channels, but also access a repeater by transmitting automatically in sequence.

Thus the repeater search scan function searches an available repeater in the area even if the repeater is not in use.

#### /// **IMPORTANT!:**

/// A microphone should be on hook to start scanning.

/// The repeater search scan detects a signal on the repeater output, CH 1 to 8, only. Therefore, repeater availability cannot be guaranteed even the repeater scan is stopped, because the scan will stop if any activity is detected. (The scan is cancelled when receiving a signal, such as stations communicating in simplex operation on a repeater output channel.)

- ① Push **[SCN]** (Scan Start/Stop) for 1 sec. to enter the scan type selection mode.
- ② Push **[^]/[v]** to select the repeater scan.

Push **[^]** or **[v]**

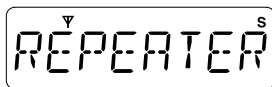
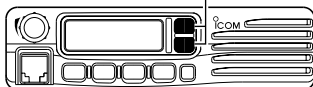

Repeater scan

- ③ Push and hold **[SCN]** (Scan Start/Stop) to return to Normal mode.

- "RS" appears when the repeater scan is selected.

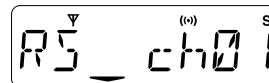

Repeater search scan

- ④ Push **[SCN]** (Scan Start/Stop) to start the repeater scan.
  - See the flow as described at right for repeater search scan details.
- ⑤ When receiving a signal on the repeater channel, scan stops.
  - 3 high beeps sound when receiving a signal, and 3 low beeps sound when no signal receiving.
- ⑥ Push **[SCN]** (Scan Start/Stop) to cancel the scanning manually.

◇ Repeater search scan flow

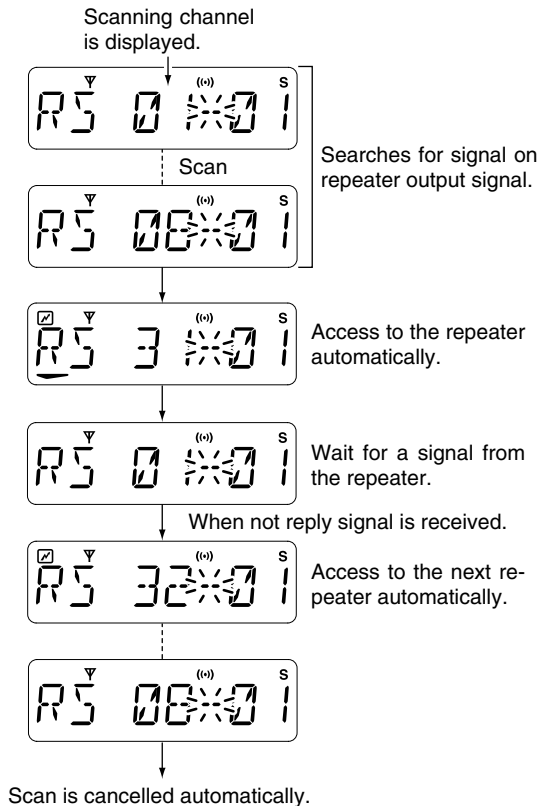

## ■ Group mode (CTCSS)

USING SET MODE

### ◇ Setting the CTCSS frequency

The IC-400PRO is equipped with 51 CTCSS frequencies for group mode operation. The group mode operation provides communication with silent stand-by since you will only receive calls from group members using the same CTCSS frequency.

First of all, set the same CTCSS frequency for all group member's transceivers.

To access the IC-40Jr or IC-4088S operating in Group mode (including Smart-Ring function), the same CTCSS frequency should be set. Select the CTCSS frequency matching the group code that is set to the IC-40Jr or IC-4088S, referring to the "Group code/frequency table" in the next page.

For example, when group code "01" is set to the IC-40Jr/IC-4088S, select "67.0" as CTCSS frequency.

**NOTE:** Only the stations with the same CTCSS frequency or matching the group code can be heard in group mode operation.

### To turn ON the group mode operation:

- ① Push [**▲**]/[**▼**] to select the desired channel.
- ② While in Function mode, push [**F**] (Bank/Func) for 1 sec. to enter Set mode.
  - Push [**F**] (Bank/Func) for 1 sec. to enter the transceiver into Function mode.
  - The bank and channel can be selected after entering Set mode.

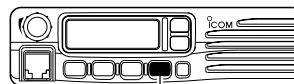

Push [**F**] for 1 sec.

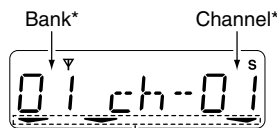

The keys under these indicators can be activated.

\*The bank and channel number are continuously displayed after entering set mode.

- ③ Push [**MONI**] for 1 sec. to enter the individual setting.
- ④ Push [**MONI**] several times until "CT" appears.

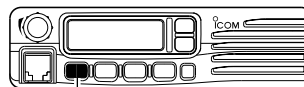

[**MONI**]



"CT" appears

- ⑤ Push [**▲**]/[**▼**] to select the desired frequency.
  - When "OFF" is displayed, push [**DUP**] to enable the tone frequency selection, in advance.
- ⑥ Push [**MONI**] for 1 sec. to exit the individual setting, then push [**F**] for 1 sec. to exit Set mode.
  - The under bar indicator appears. (p. 4)

**To cancel the group mode operation:**

- ① While in Function mode, push **[F]** (Bank/Func) for 1 sec. to enter Set mode.
  - Push **[F]** (Bank/Func) for 1 sec. to enter the transceiver into Function mode.
- ② Push **[MONI]** for 1 sec. to enter the individual setting.
- ③ Push **[MONI]** several times until “CT” appears.
- ④ Push **[DUP]** to select “OFF” (group mode OFF).

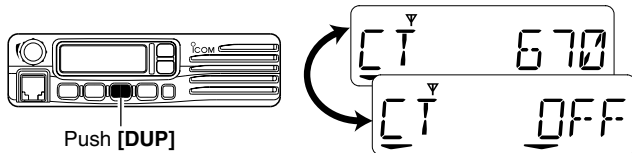

- ⑤ Push **[MONI]** for 1 sec. to exit the individual setting, then push **[F]** for 1 sec. to exit Set mode.
  - The under bar indicators disappear.

**◆ Group code/frequency table** (unit: Hz)

Code	Freq.	Code	Freq.	Code	Freq.	Code	Freq.	Code	Freq.
01	67.0	10	94.8	21	136.5	28	173.8	---	206.5
---	69.3	11	97.4	22	141.3	---	177.3	33	210.7
---	71.0	12	100.0	23	146.2	29	179.9	34	218.1
02	71.9	13	103.5	24	151.4	---	183.5	35	225.7
03	74.4	14	107.2	25	156.7	30	186.2	---	229.1
04	77.0	15	110.9	---	159.8	---	189.9	36	233.6
05	79.7	16	114.8	26	162.2	31	192.8	37	241.8
06	82.5	17	118.8	---	165.5	---	196.6	38	250.3
07	85.4	18	123.0	27	167.9	---	199.5	---	254.1
08	88.5	19	127.3	---	171.3	32	203.5	---	OFF
09	91.5	20	131.8						

**✓ What is CTCSS (Continuous Tone Coded Squelch System) GROUP MODE ?**

CTCSS (Continuous Tone Coded Squelch System) GROUP MODE allows communication with silent stand by. Only signals containing a specific CTCSS frequency can open the squelch.

This conveniently eliminates unwanted audio and is useful in group activities or security related activities where unwanted output can be a problem. Note that CTCSS group mode is not private—anyone can receive your calls.

The IC-400PRO is equipped with 51 CTCSS frequency for CTCSS GROUP MODE use. Selecting a CTCSS frequency applies it to all 40 operating channels. To temporarily hear all signals (including noise) push and hold **[MONI]**. Do not use CTCSS GROUP MODE if you want to hear signals on all channels.

■ : Stands for the recommended CTCSS frequency. In case a frequency other than at left is used, sometimes the squelch system may not performed correctly.

## ■ General

In addition to the group mode operation for silent stand-by, the SelCall operation is available. SelCall is an abbreviation for “Selective Calling”. In Group mode operation, there are 51 ways to make an individual call with CTCSS frequencies versus 100,000 ways to make an individual call with Selcall using 5tone.

SelCall allows you to selectively call another unit that is operating on the same channel.

SelCall can also call the entire group on that channel using group call code.

The caller station code/name, status message, Answer Back function, automatic scan start function, etc. are available with SelCall operation. A variety of functions are available depending on the setting with the CS-400PRO CLONING SOFTWARE. See the help file for setting details.

## ■ Calling operation

### ◇ TX code channel selection

The [MONI] (Call) key (in Function mode) enables you to change the TX code channel with [▲]/[▼] keys.

▨ **TX code** is transmit SelCall code. Max. 32 TX code channels can be pre-programmed into the IC-400PRO using the optional CS-400PRO CLONING SOFTWARE.

#### To select a TX code channel:

- ① While in Function mode, push [MONI] (Call) for 1 sec. to enter the TX code channel selection mode.
  - Push [F] (Bank/Func) for 1 sec. to enter the transceiver into Function mode.

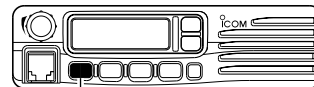

Push [MONI] for 1 sec.

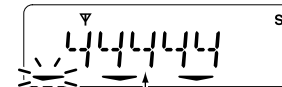

The TX code or TX code channel name (if programmed) is displayed.

- ② Push [▲]/[▼] to select the desired TX code channel.

Push [▲] or [▼]

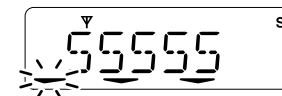
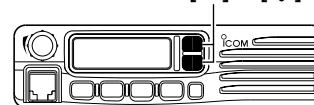

- ③ Push **[MONI]** (Call) to set the TX code channel, and return to Function mode.

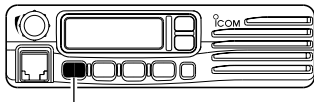

Push **[MONI]**

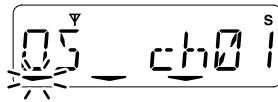

- ④ Push **[MONI]** (Call) to transmit the code on the selected channel.

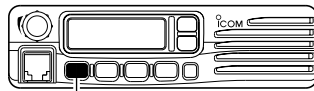

Push **[MONI]**

Appears while transmitting

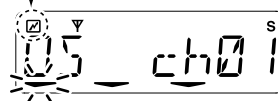

✓ **CONVENIENT!**

- The TX code channel name can be assigned to the all 32 TX code channel via the optional CS-400PRO CLONING SOFTWARE. The TX code channel name allows you to easy to select the channel, find the channel user, and so on.
- The long tone function is useful and provides you to proper individual or group call even through a repeater, or when the calling station is in scanning operation. The long tone function can be activated in Set mode. (p. 30)

◇ **TX code number edit**

The **[MONI]** (Call) key (in Function mode) enables you to change the TX code contents within the allowable digits. The group call function works by allowing you to edit a special 'group code' into the last 2 digits position of the SelCall ID code.

**To edit a TX code:**

- ① While in Function mode, push **[MONI]** (Call) for 1 sec. to enter the TX code channel selection mode.
  - Push **[F]** (Bank/Func) for 1 sec. to enter the transceiver into Function mode.
  - Push **[^]/[v]** to select the desired TX code channel, if desired.
- ② Push **[MONI]** (Call) for 1 sec. again to enter the TX code edit mode.

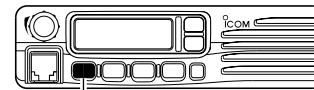

Push **[MONI]** for 1 sec.

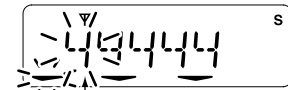

The first digit starts blinking

- ③ Push **[MONI]** (Call) to select the desired digit to be edited.
  - Editable digit blinks

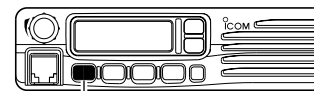

Push **[MONI]**

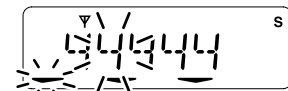

## 6 SELCALL OPERATION

- ④ Push [**▲**]/**[▼]** to set the desired code.

• Select “\*” when group code is set.

Push [**▲**] or **[▼]**

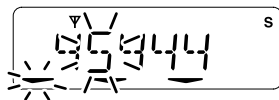
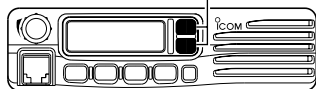

- ⑤ Push **[MONI]** (Call) to set the code and the editable digit move to right automatically.

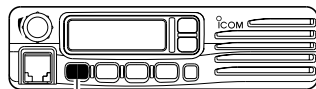

Push **[MONI]**

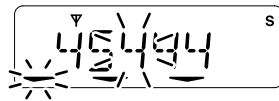

- ⑥ Repeat step ④ and ⑤ to input all allowed digits.  
⑦ Push **[MONI]** (Call) to set the TX code.

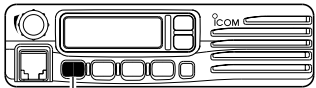

Push **[MONI]**



- ⑧ Push **[MONI]** (Call) to return to Function mode.

- ⑨ Push **[MONI]** (Call) to transmit the code on the selected channel.

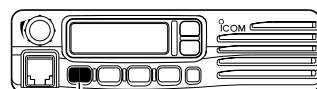

Push **[MONI]**

Appears while transmitting

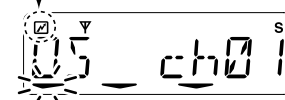

**NOTE:** The TX code editable digit can only be set/changed with the optional CS-400PRO CLONING SOFTWARE.



## ■ When receiving a call

### ◇ Receiving an individual call

When receiving an individual call (default setting);

- “PiRo” beeps sound repeatedly for 10 sec.
- Transmits the answer back call with single tone for 2 sec.
- The received ID code is displayed and memorised into the transceiver.
- “▲” and “◀||” appear, and the channel turns ‘Audible’ condition (mute is released)

/// **RX code** is receiving SelCall code. Max. 8 RX code channels can be pre-programmed into the IC-400PRO using the optional CS-400PRO CLONING SOFTWARE.

You can set the transceiver condition when receiving an individual call using the CS-400PRO CLONING SOFTWARE. See the help file for setting details.

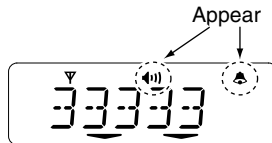

#### Recall the memorised RX code:

- ① During in Function mode, push [SCN] (ID-MR Select) to display the memorised RX code.
- ② Push [▲]/[▼] to select the desired RX code.
- ③ Push [MONI] (Call) to transmit the code on the selected channel.

### ◇ Receiving a group call

When receiving a group call (default setting);

- “PiPi” beep sounds.
- “GROUP” is displayed.
- “▲” blinks and “◀||” appears, and the channel turns ‘Audible’ condition (mute is released)

You can set the display condition when receiving a group call with the CS-400PRO CLONING SOFTWARE. See the help file for setting details.

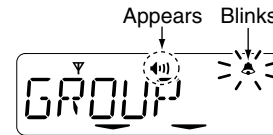

### ◇ Answering a call

- ① When receiving a call (individual or group call), the indicators appear as at left/above.
- ② Push any key to return to the condition before receiving a call.
  - “▲” still lights/blinks on the display.
- ③ Then push [PTT] to communicate via the microphone with the caller, if desired.

## 6 SELCALL OPERATION

### ■ Setting the silent stand-by condition

The SelCall mute condition allows silent operation until you are selcalled.

- ① While in Function mode, push **[DUP]** (CONT/SGL) and select the single tone to activate the SelCall mute ('Inaudible' condition).

- Push **[F]** (Bank/Func) for 1 sec. to enter the transceiver into Function mode.
- When the single tone is selected, "SGL" is displayed briefly, and the under bar appears as below.

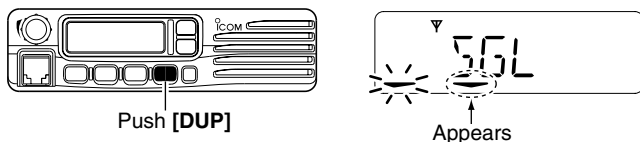

- ② Push **[F]** for 1 sec. to enter Set mode, and push for 1 sec. again to return to Normal mode.

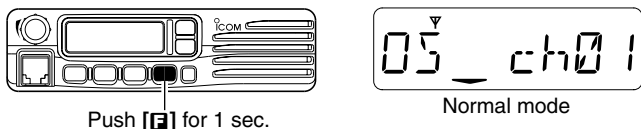

- ③ To monitor the channel;

Push **[MONI]** (Moni(Audi)) for 1 sec. to release the SelCall mute (audio is emitted; 'Audible' condition).

- "◀▶" appears.

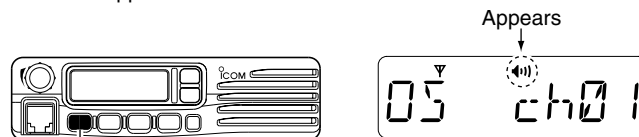

Push **[MONI]** for 1 sec.

- ④ To enable SelCall mute;

When "◀▶" appears, push the key to mute the channel (sets to 'Inaudible').

- "◀▶" disappears.

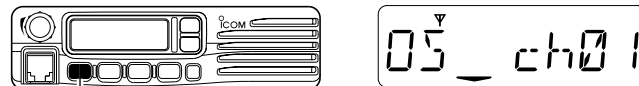

**NOTE:** The unmute condition ('Audible' condition) may automatically return to the mute condition ('Inaudible' condition) after a specified time period depending on the pre-setting.

## Smart-Ring and ATS (Automatic Transponder System)

KEY ASSIGNMENT

These functions have an answer back feature, and allows you to confirmation of whether or not a call has reached the receiving party even if the operator is temporarily away from the transceiver. The Smart-Ring is for manual, and the ATS is for automatic confirmation. Both functions are compatible with the IC-40Jr and IC-4088S.

▨ **[ATS/S-ring]** must be assigned to the desired programmable key using the optional CS-400PRO CLONING SOFTWARE.

### ◇ Smart-Ring

- ① Set the same CTCSS frequency (or group code) for all of the group transceivers. (See p. 15)
- ② Push **[ATS/S-ring]**.

Appears while transmitting

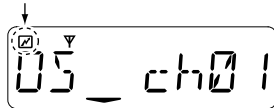

Blinks when a group member answers a call.

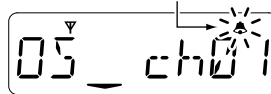

- A beep is emitted and “☑” appears on the display.
- When a member of a specific group answers a call, “☀” blinks.
- When no answer back is received, the transceiver emits short faint beep tones.

- ③ Push **[PTT]** to answer and to stop the flashing.

▨ **NOTE:** This function is available only when the called station has set the same CTCSS frequency (or group code) and the same operating channel as you.

### ◇ ATS

- Push **[ATS/S-ring]** for 1 sec. to turn the function ON.
  - The transceiver starts to send a searching signal every 60 sec.
  - “☑” and “▽” appear on the display when the function is activated.

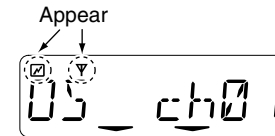

- When the transceiver receives an answer back signal, “▽” stays on the display until the next search transmit.
- If no reply is received, “▽” blinks until the next search transmit.

### ▨ NOTE:

- The setting at left is for the calling station only. A called party automatically sends an answer back signal without any presettings. All IC-400PRO's operating on the same operating channel will answer back to the call in the surroundings communications area.
- When the CTCSS frequency (or group code) is set to the IC-400PRO, this function is available only for the same frequency (code) setting.

## ■ Voice scrambler function (optional UT-109/110 is required)

USING **SET MODE**

The voice scrambler function provides communication privacy. The optional UT-109/110 (#02) VOICE SCRAMBLER UNITS provides high performance private communication between stations with the same scrambling codes. The scrambler is not compatible with the IC-4088S's scrambler system.

- The scrambler group code is must be set in advance using the optional CS-400PRO when the UT-110 is installed.
- ACA class licence inhibits using this function in channels 5, 11 and 35, or while accessing a repeater.

- ① Push [**▲**]/[**▼**] to select the desired channel.
  - Except for the channels 5, 11 or 35.
- ② While in Function mode, push [**F**] (Bank/Func) for 1 sec. to enter Set mode.
  - Push [**F**] (Bank/Func) for 1 sec. to enter the transceiver into Function mode.

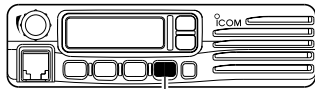

Push [**F**] for 1 sec.

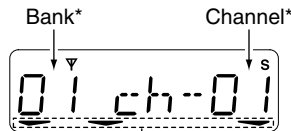

\*The bank and channel number are continuously displayed after entering set mode.

The keys under these indicators can be activated.

- ③ Push [**MONI**] for 1 sec. to enter the individual setting.
- ④ Push [**MONI**] several times until "SCR" appears.

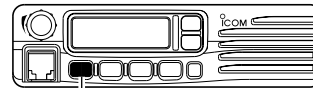

Push [**MONI**]



"SCR" appears

- ⑤ Push [**DUP**] to turn the scrambler function ON.

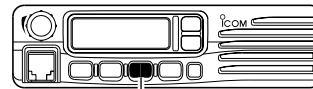

Push [**DUP**]

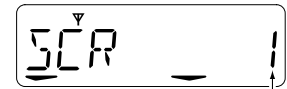

The scrambler code appears

- ⑤ Push [**▲**]/[**▼**] to select the desired code.
  - Available codes;
    - UT-109 (Non-rolling type): 1 to 32
    - UT-110 (Rolling type): 1 to 255

Push [**▲**] or [**▼**]

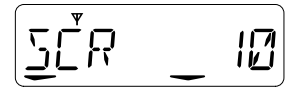
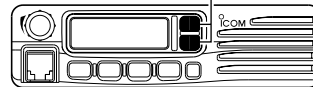

- ⑥ Push [**MONI**] for 1 sec. to exit the individual setting, then push [**F**] for 1 sec. to exit Set mode.

## ■ DTMF transmission

### KEY ASSIGNMENT

Up to 8 DTMF (Dual Tone Multiple Frequency) code channels are available for storage of often used DTMF codes of up to 24 digits and the automatic DTMF transmission function is available without using the optional HM-100TN DTMF MICROPHONE.

DTMF signaling can be used for remote control via phone patch system, etc.

▨ [DTMF Autodial] must be assigned to the desired programmable key using the optional CS-400PRO CLONING SOFTWARE.

### To transmit a DTMF code:

- ① Push [DTMF Autodial]—a DTMF code channel appears.



- ② Push [^]/[v] to select the desired DTMF channel.
- ③ Push [DTMF Autodial] to transmit the DTMF code the selected DTMF channel.

▨ If the transceiver has a [Re-dial] key, the last transmitted DTMF code is sent immediately when pushing the key.

## ■ Channel lock function

### KEY ASSIGNMENT

This function electronically locks [^], [v], [SCN] (Scan Start/Stop)/(ID-MR Select), [MR-CH 1] to [MR-CH 4] and [Hook Scan] keys (if assigned) to prevent accidental channel change.

▨ [Ch Lock] must be assigned to the desired programmable key using the optional CS-400PRO CLONING SOFTWARE.

- ➔ Push [Ch Lock] for 1 sec. to turn the channel lock function ON and OFF.

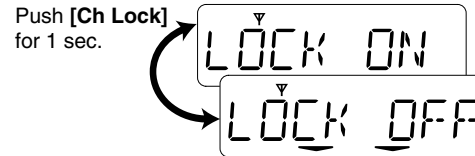

## ■ RX frequency setting (for private banks only)

USING SET MODE

The receive frequency in the private bank channels can be re-programmed within 450 to 500 MHz frequency range depending on the setting.

- ① Push [**▲**]/[**▼**] to select the desired channel.
- ② While in Function mode, push [**F**] (Bank/Func) for 1 sec. to enter Set mode.
  - Push [**F**] (Bank/Func) for 1 sec. to enter the transceiver into Function mode.
  - The bank and channel can be selected after entering Set mode.

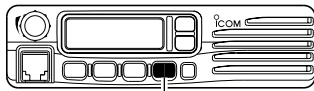

Push [**F**] for 1 sec.

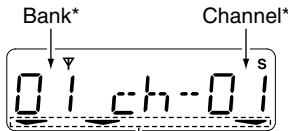

The keys under these indicators can be activated.

\*The bank and channel number are continuously displayed after entering set mode.

- ③ Push [**MONI**] for 1 sec. to enter the individual setting.
- ④ Push [**MONI**] several times until the RX frequency appears.

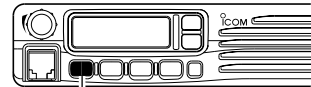

Push [**MONI**]



RX frequency appears

- ⑤ Push [**DUP**] to enter the RX frequency setting mode.

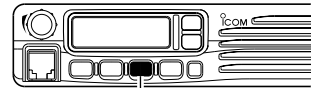

Push [**DUP**]



The first digit starts blinking.

- ⑥ Push [**DUP**] to select the desired digit to be edited.

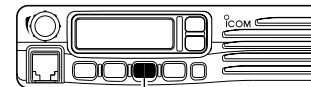

Push [**DUP**]



- ⑦ Push [**▲**]/[**▼**] to set the desired number.

Push [**▲**] or [**▼**]

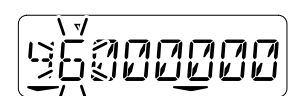
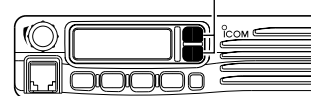

- ⑧ Push **[DUP]** to set the number and the editable digit move to right.

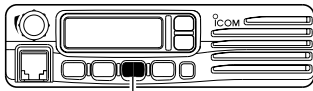

Push **[DUP]**

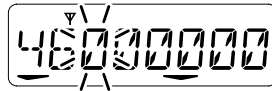

- ⑨ Repeat step ⑦ and ⑧ to input the desired frequency.  
⑩ Push **[DUP]** to set the RX frequency.

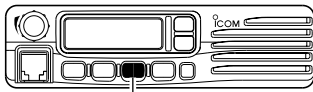

Push **[DUP]**



- ⑪ Push **[MONI]** for 1 sec. to exit the individual setting, then push **[M]** for 1 sec. to exit Set mode.

### ✓ CONVENIENT!

The 5-digit channel name can be programmed using the optional CS-400PRO CLONING SOFTWARE.

## Wide/Narrow function

KEY ASSIGNMENT

This function temporarily changes the bandwidth between wide or narrow on Private channels only.

**[Wide/Narrow]** must be assigned to the desired programmable key using the optional CS-400PRO CLONING SOFTWARE.

- ➔ Push **[Wide/Narrow]** to toggle the bandwidth between wide or narrow.

Push  
**[Wide/Narrow]**

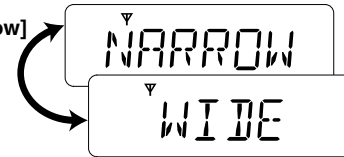

### ■ Set mode

Set mode allows you to change seldom used common setting for the transceiver, or individual setting for the operating channel. In this case you can “customize” transceiver operation to suit your preferences and operating style.

/// To enter the common setting for the transceiver, or individual setting, push the appropriate key in step ⑤ below.

#### **Entering the Set mode:**

- ① Push [**B**] (Bank/Func) to enter the channel bank selection mode. Then select the desired channel bank with [**▲**]/**[▼]** key. Push [**B**] (Bank/Func) again to exit the channel bank selection mode.
- ② Push [**▲**]/**[▼]** to select the desired channel when you change the individual setting.  
\*The bank and channel can be selected after entering Set mode.
- ③ Push [**B**] (Bank/Func) for 1 sec. to enter the Function mode.
- ④ Push for 1 sec. again to enter the Set mode.

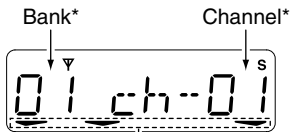

The keys under these indicators can be activated.

\*The bank and channel number are continuously displayed after entering set mode.

- ⑤ Push [**SCN**] for 1 sec. to change the common setting, or [**MONI**] for the individual setting.
- ⑥ Push [**SCN**]/**[MONI]** (the same key that you pushed in step ⑤) to select the appropriate item. Then, push [**▲**]/**[▼]** to set the desired level/mode or [**DUP**] to turn the function ON or OFF (depending on the selected item).
- ⑦ After pushing [**SCN**]/**[MONI]** (the same key that you pushed in step ⑤) for 1 sec., push [**B**] for 1 sec. to exit Set mode.

/// **NOTE:** The displayed items can be changed depending on the pre-setting via the optional CS-400PRO CLONING SOFTWARE.



◆ Set mode flow chart

The following flow chart describes Set mode details.

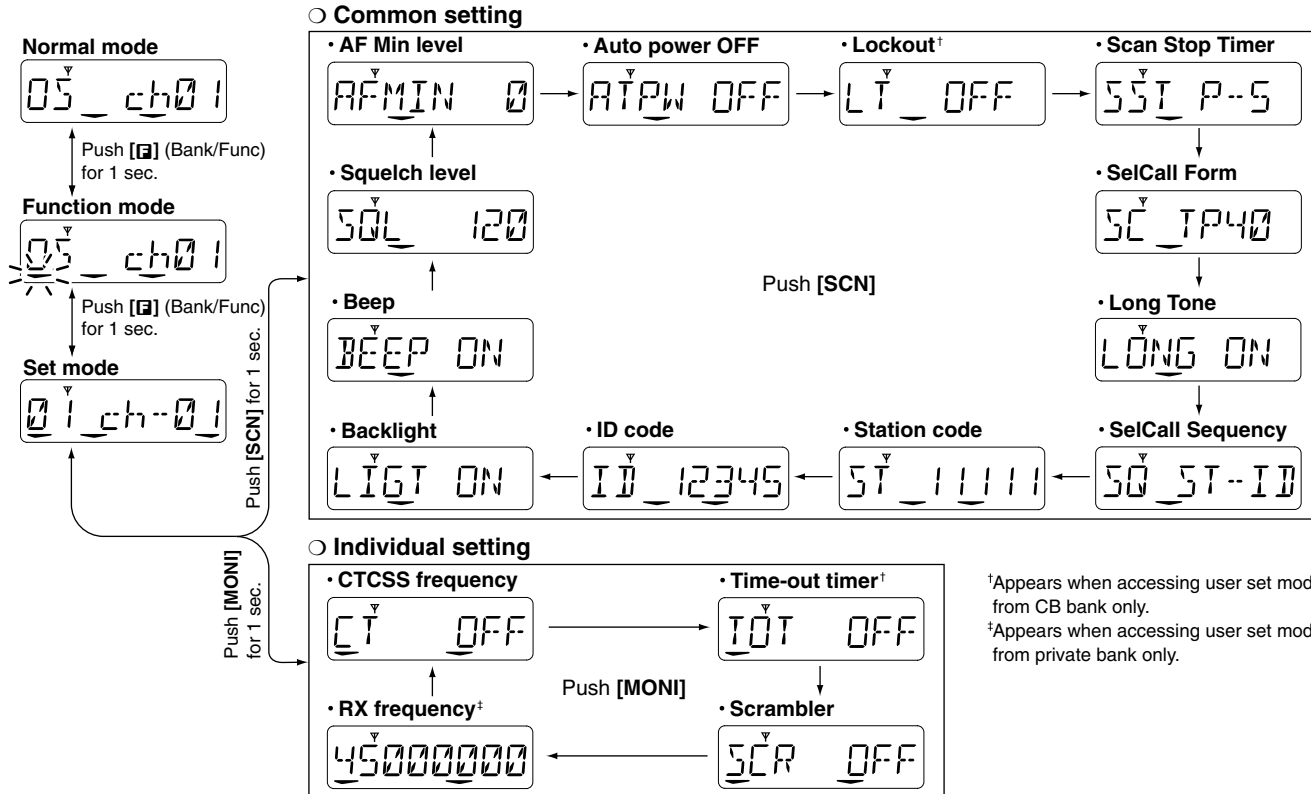

## 7 OTHER FUNCTIONS

### ◆ Common setting

#### • Backlight condition

The transceiver has display backlight for night-time operation. Select the desired condition.

- OFF : Backlight never lights.
- DIM : Backlight lights dimly.
- AUT : Backlight turns ON when no signal applied to external DIM terminal, and lights dimly when a signal applied to external DIM terminal (optional OPC-617 ACC CABLE is required).
- ON : Backlight lights continuously.

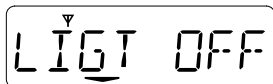

Backlight is OFF

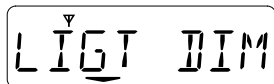

DIM setting

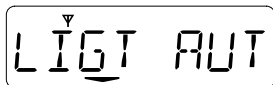

AUT setting

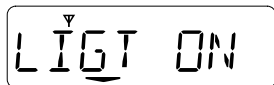

Continuously ON setting

#### • Beep condition

The key-touch beeps can be turned ON and OFF.

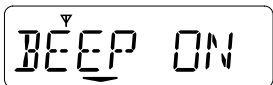

Beep ON

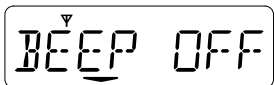

Beep OFF  
(silent operation)

#### • Squelch level

Adjust the noise squelch level within a 0 to 255 range.

- The lower the set value is the easier it is for the squelch to open, and easier for the scan to stop.

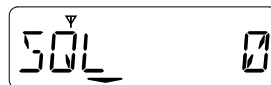

0 setting



120 setting

#### • AF Min level

Adjust the minimum audio output level within a 0 to 255 range.



0 setting



255 setting

#### • Auto Power OFF

The transceiver can be set to automatically turn OFF after 2 hours in which no operations are performed and receiving no signal.

To cancel the function, select "OFF" in Set mode.

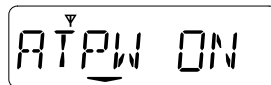

Turn OFF after 2 hours



This function is OFF

### • Lockout CB

Select the transmission lockout (temporary transmission inhibit) capability from OFF, Busy and Rpt 1 for CB mode.

- OFF: No restriction for receiving a signal.
- BUSY (Busy Lockout): Transmission is inhibited while receiving a signal.
- RPT1 (Repeater Lockout (1)): Transmission is permitted only while receiving a matched CTCSS tone, or receiving no signal.

LT OFF

Lock-out function is OFF.

LT BUSY

Busy setting

LT RPT1

Rpt1 setting

### • Scan stop timer

The scan resume condition can be selected as a pause or timer scan.

- T-5/10/15 : Scan pauses 5/10/15 sec. while receiving a signal.
- P-5 : Scan pauses until the signal disappears and then resumes 5 sec. thereafter.

SST P-5

P-5 setting

SST T-15

T-15 setting

### • SelCall Format

Select the SelCall format from CCIR, ZVEI1, ZVEI2, DZVEI, EEA, EEA2, DAPL, TP40, TP100, DTMF, IC20 and INH.

- The optional UT-108 DTMF DECODER UNIT is required to select “DTMF”.
- “TP40” and “TP100” are compatible with other manufacture’s CB transceiver SelCall.

SC TP40

TP40 setting

SC INH

SelCall inhibit setting

### • Long tone

Select the long tone function to activate the long tone capability for CB mode.

LONG ON

The long tone function is ON

LONG OFF

The long tone function is OFF

### • SelCall sequence

Select the own ID code sending sequence from ST and ST-ID.

- ST : Does not send the ID code.
- ST-ID: Sends the ID code after sending station or group code.

SQ ST

STN setting

SQ ST-ID

STN+ID setting

## 7 OTHER FUNCTIONS

### • STN code (Station to be called)

- Select the station code channel with [^]/[v] key.
- Set the desired station code following the steps as below.
  - ① While the station code is displayed, push [DUP] to enter the station code edit mode.
  - ② Push [DUP] to select the desired digit to be edited.
    - Editable digit blinks
  - ③ Push [^]/[v] to set the desired code.
    - Select "\*" when group code is set.
  - ④ Push [DUP] to set the code and the editable digit move to right automatically.
  - ⑤ Repeat step ③ and ④ to input all allowed digits.
  - ⑥ Push [DUP] to set the station code.

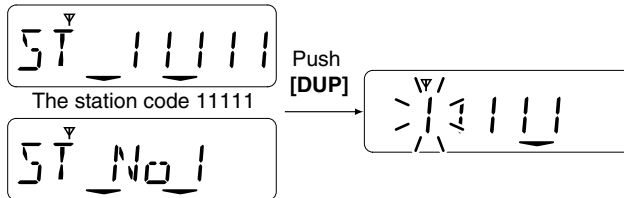

The code channel name is displayed.  
(if programmed)

### • ID code (Self ID number)

- Select the ID code channel with [^]/[v] key.
- Set the desired ID code in the same way as the station code setting.

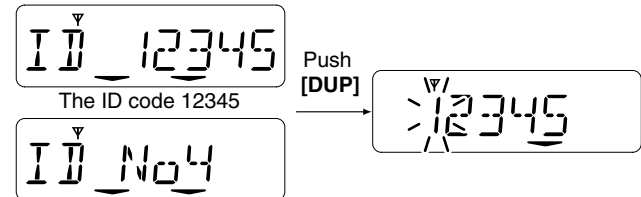

The code channel name is displayed.  
(if programmed)

## ◆ Individual setting

### • CTCSS function

Select CTCSS frequency.

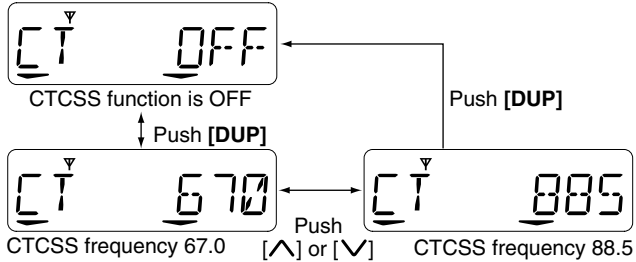

### • Time-out timer

Turn the time-out timer function ON or OFF to limit continuous transmission.

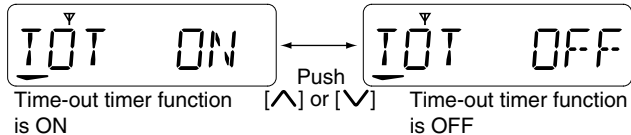

### • Scrambler function (The optional UT-109/110 is required)

Set the scrambler codes to provides high performance private communication between stations with the same codes. ACA class licence inhibits using this function in channels 5, 11 and 35, or while accessing a repeater. (p. 23)

- UT-109: 1 to 32
- UT-110: 1 to 255

/// The scrambler group code is must be set in advance using the optional CS-400PRO when the UT-110 is installed.

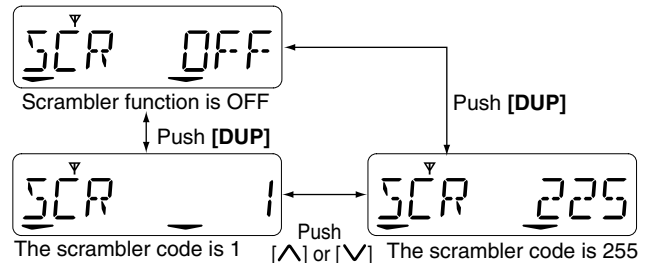

## 7 OTHER FUNCTIONS

### • RX frequency

The receive frequency can be re-programmed from the transceiver if permitted. (p. 25)

- ① While the receive frequency is displayed, push **[DUP]** to enter the RX frequency setting mode.
- ② Push **[DUP]** to select the digit to be edited.
- ③ Push **[^]/[v]** to set the desired number.
- ④ Push **[DUP]** to set the number and the editable digit move to right.
- ⑤ Repeat step ③ and ④ to input the desired frequency.
- ⑥ Push **[DUP]** to set the RX frequency.

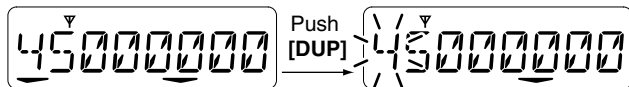

Receive frequency is 450.000000

The following functions can be assigned to [MONI], [SCN], [DUP], [E], [^] and [V] programmable function keys with the optional CS-400PRO CLONING SOFTWARE.

In the following explanations, programmable function names are bracketed. The specific switch used to activate the function depends on programming.

## CH UP AND DOWN KEYS

- In standby condition, push to select an operating channel.
- After pushing [BANK/FUNC], push to select the desired channel bank.

\*The private channels are set in the channel bank 2 to 8. Select the desired channel bank before operating the private mode.

## BANK/FUNC KEY

- Push to enter channel bank selection mode.
  - In channel bank selection mode, push [^]/[V] to select the desired channel bank.
- Push for 1 sec. to toggle Function mode, Set mode or Normal mode.
  - Returns to the Normal mode automatically after 30 sec. when no key operations are performed in Function or Set mode.

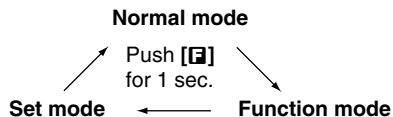

/// **NOTE:** This key should be assigned to Normal/Function mode respectively to change the key mode.

## SCAN START/STOP KEY

- Push to start or stop the scan.
- Push and hold to enter the scan type selection mode.
  - Push [CH Up]/[CH Down] to select the desired scan type.
- In scan type selection mode, push to set the channel as a tag channel.
  - “S” appears for tag channels.

/// **NOTE:** Place the microphone on hook to start scanning.  
/// Take the microphone off hook to stop scanning.

## MR-CH 1/2/3/4 (Private bank only)

Push to select the operating channels 1 to 4 directly.

## OUTPUT POWER SELECTION KEYS

Select the transmit output power temporarily, or permanently, depending on the pre-setting.

- See the help file of the optional CS-400PRO CLONING SOFTWARE for the output power level for each selection.

---

## 8 PROGRAMMABLE FUNCTION KEYS

### **MONITOR KEY**

Activates one of (or two of) the following functions on each channel independently:

- Push and hold the key to unmute the channel (audio is emitted; 'Audible' condition).
- Push the key to toggle between the mute and unmute conditions (toggles between 'Audible' and 'Inaudible').
- Push the key to mute the channel (sets to 'Inaudible' only).
- Push the key to unmute the channel (sets to 'Audible' only).
- Push the key after communication is finished to send a 'reset code'.

**NOTE:** The unmute condition ('Audible' condition) may automatically return to the mute condition ('Inaudible' condition) after a specified period depending on the pre-setting.

### **WIDE/NARROW KEY** (Private bank only)

Push this key to toggle the bandwidth between wide or narrow.

### **DTMF AUTODIAL KEY**

Push this key to display the text of the DTMF channel number and set the desired channel number via the **[CH Up]/[CH Down]** key. Then, push this key again to transmit a specified DTMF code.

### **RE-DIAL KEY**

Push to send the last transmitted DTMF code.

### **CALL KEY**

- ➔ Push to transmit the 5tone code on the selected channel.
- ➔ Push and hold to enter the 5tone code channel/number selection mode. (pgs. 17, 18)
  - Push **[CH Up]/[CH Down]** to select the desired channel/ number.

### **ID-MR SELECT KEY**

- ➔ Push to recall the received ID code.  
Push **[CH Up]/[CH Down]** to select the record.

### **HOOK SCAN**

Push to turn the hanger action scan function (automatic scan start when on hook) OFF temporarily, and push again to turn the function ON.

### **ATS/S-RING KEY**

- ➔ Push to transmit the Smart-ring signal to the other station.
- ➔ Push for 1 sec. to turn the ATS function ON and OFF.

### **CH LOCK KEY**

This function electronically locks **[CH Up]**, **[CH Down]**, **[Scan Start/Stop]**, **[MR-CH 1]** to **[MR-CH 4]**, **[ID MR Select]** and **[Hook Scan]** keys to prevent accidental channel change.



**DUP/PRI KEY**

- Push to toggle the transmit frequency mode between duplex and simplex.
  - Duplex: The set TX frequency is used for the transmission.
  - Simplex: The set RX frequency is used for the transmission.
- Push for 1 sec. to set the selected channel to priority or normal.
- Priority channel is used for group or priority scan.

**CONT/SGL KEY**

Push to toggle the 5tone mute activity CONT (Continuous Tone) and SGL (Single Tone).

# 9

## CONNECTION AND MAINTENANCE

### ■ Rear panel and connection

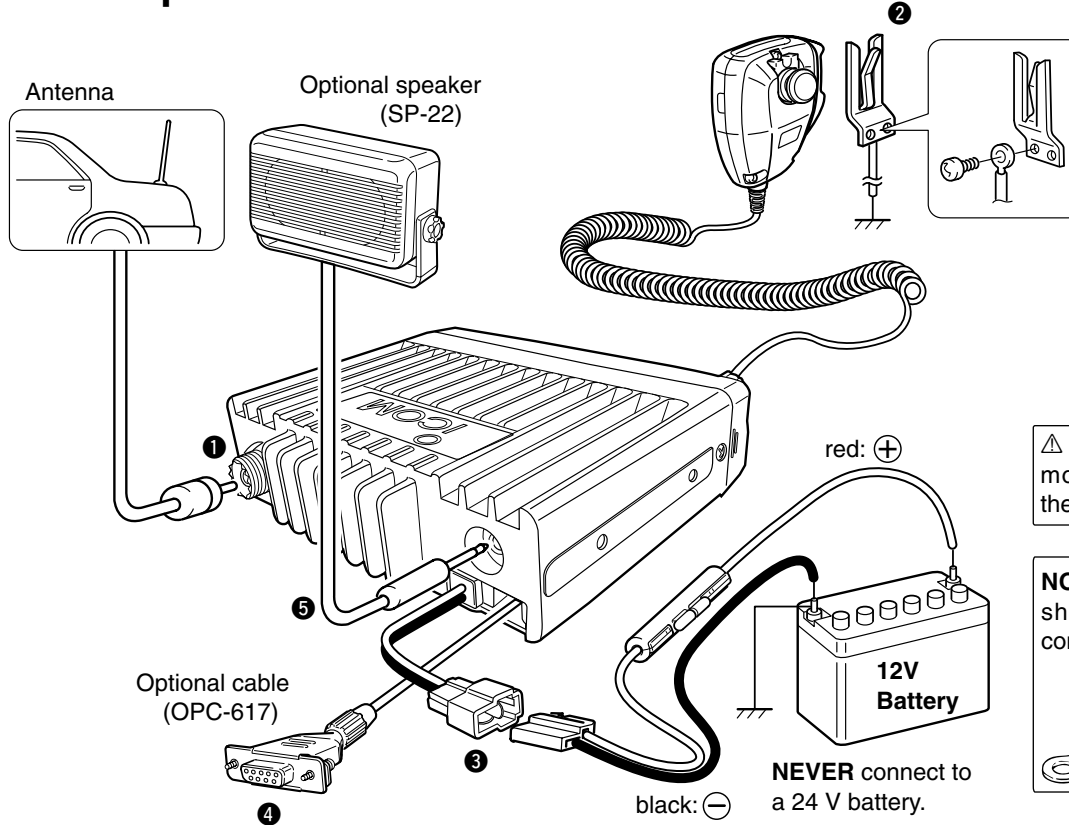

**IMPORTANT!** The microphone hanger connection is necessary to use the scanning function.

**CAUTION!** NEVER remove the fuse-holder from the DC power cable.

**NOTE:** Use the terminals as shown below for the cable connections.

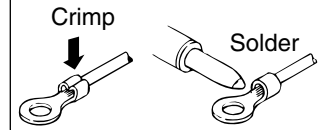

**1 ANTENNA CONNECTOR**

Connects to an antenna. Contact your dealer about antenna selection and placement.

**2 MICROPHONE HANGER**

Connect the supplied microphone hanger to the vehicle's ground for microphone on/off hook functions. (See p. 3)

**IMPORTANT!:**

The microphone hanger connection is necessary to use the scanning function. Scan starts when a microphone on hook.

**3 DC POWER RECEPTACLE**

Connects to a **12 V DC** battery. Pay attention to polarities.

**NEVER** connect to a **24 V** battery. This could damage the transceiver.

**4 OPTIONAL CABLE (OPC-617)**

Connect an external modem unit, dimmer control, etc.

**5 EXTERNAL SPEAKER JACK**

Connect a 4–8 Ω (5 W) external speaker, if desired.

**Mounting the transceiver**

The universal mounting bracket supplied with your transceiver allows overhead mounting.

- Mount the transceiver securely with the 4 supplied screws to a thick surface which can support more than 1.5 kg.

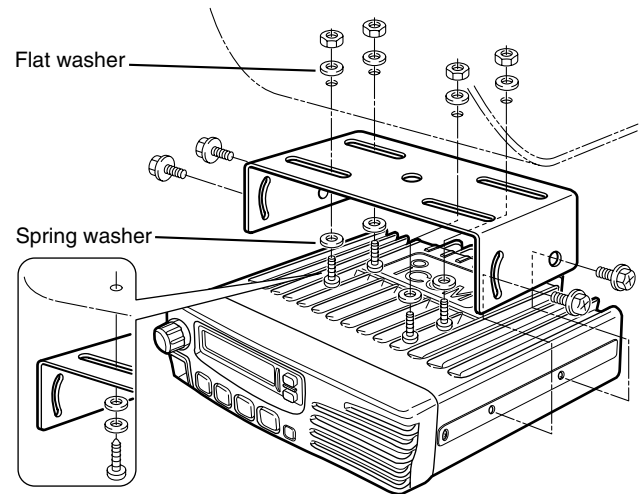

When using self-tapping screws

### ■ Optional UT-108 installation

Install the optional UT-108 unit as follows:

- ① Turn the power OFF, then disconnect the DC power cable.
- ② Unscrew the 4 cover screws, then remove the bottom cover.
- ③ Install the unit as shown in the diagram below.
- ④ Replace the bottom cover and screws, then re-connect the DC power cable.

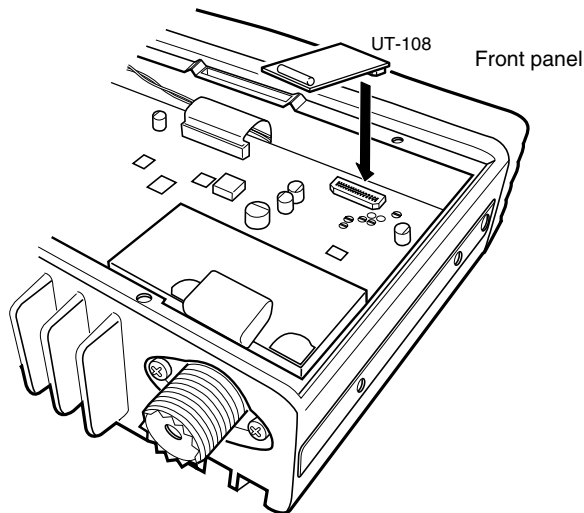

### ■ Optional UT-109 or UT-110 installation

- ① Turn the power OFF, then disconnect the DC power cable.
- ② Unscrew the 4 cover screws, then remove the bottom cover.
- ③ Cut the pattern on the PCB at the TX mic circuit (MIC) and RX AF circuit (DISC) as shown below.
- ④ Install the scrambler unit as described in the installation of optional UT-108 as on the page at left.
- ⑤ Replace the bottom cover and screws, then re-connect the DC power cable.

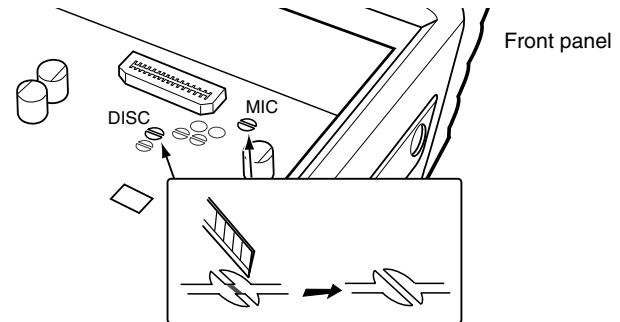

**NOTE:** Be sure to re-solder the above disconnected points when you remove the scrambler units. Otherwise no TX modulation or AF output is available.

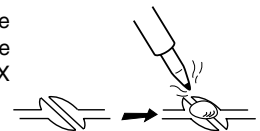

## Optional OPC-617 installation

Install the OPC-617 as shown below.

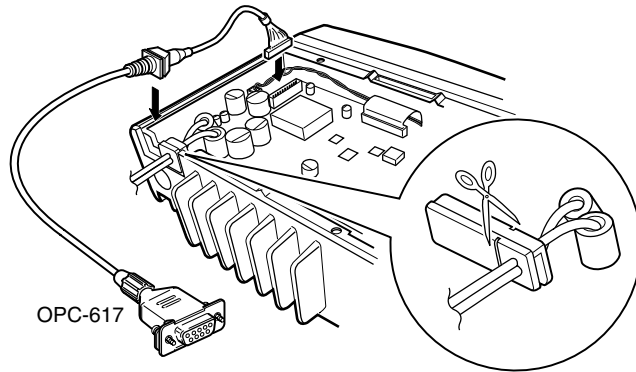

Cut off the bushing as in the illustration, when you install the optional OPC-617.

## Antenna

A key element in the performance of any communication system is an antenna. Contact your dealer about antennas and the best places to mount them.

## Fuse replacement

A fuse is installed in the supplied DC power cable. If a fuse blows or the transceiver stops functioning, track down the source of the problem if possible, and replace the damaged fuse with a new rated one.

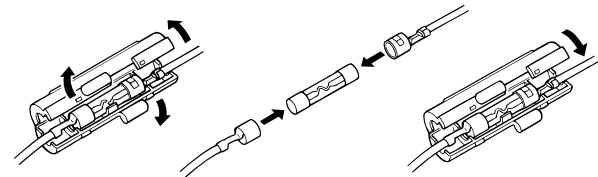

□ Fuse rating: 10 A

## Cleaning

If the transceiver becomes dusty or dirty, wipe it clean with a soft, dry cloth.



**AVOID** the use of solvents such as benzene or alcohol, as they may damage the transceiver surfaces.

### OPTIONAL CABLE PIN ASSIGNMENT

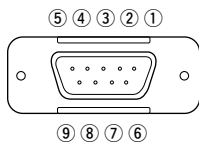

- |                                     |                        |
|-------------------------------------|------------------------|
| ① Dimmer cont. IN or IGSW cont. IN  | ⑥ Horn drive cont. OUT |
| ② AF OUT                            | ⑦ AF GND               |
| ③ Det. AF OUT                       | ⑧ Det. AF GND          |
| ④ Mod. IN                           | ⑨ Mod. GND             |
| ⑤ PTT control IN or FTSW control IN |                        |

# 10 SPECIFICATIONS

## ◆ GENERAL

- Frequency coverage
  - CB : 476.425–477.400 MHz
  - Private : 450.000–500.000 MHz (RX only)
- Mode
  - CB : 16K0F3E
  - Private : 16K0F3E (Wide)/8K50F3E (Narrow)
- Number of channels
  - CB : 40 channels/1 bank
  - Private : 88 channels/7 banks
- Channel spacing
  - CB : ±25 kHz
  - Private : ±25 kHz (Wide)/±12.5 kHz (Narrow)
- Current drain (approx.)
  - TX : (at 5W) 4 A
  - RX : Max. audio 1200 mA  
Stand-by 300 mA
- Power supply voltage : 13.8 V DC
- Frequency stability : ±2.5 ppm
- Antenna connector : SO-239 (50 Ω)
- Usable temperature range : -10°C to +60°C
- Dimensions : 150 (W) × 40(H) × 117.5(D) mm  
(Projections not included)
- Weight (approx.) : 800 g

## ◆ TRANSMITTER

- Output power (at 13.8 V DC) : 5 W
- Modulation system : Variable reactance frequency modulation
- Max. frequency deviation : ±5 kHz
- Spurious emissions : -30 dBm
- Adjacent channel power : -22 dBm

## ◆ RECEIVER

- Sensitivity (12 dB SINAD) : 0.25 μV typ.
- Squelch sensitivity : 0.25 μV typ. (Threshold)
- Intermodulation rejection ratio: 70 dB
- Spurious response rejection ratio: 75 dB
- Adjacent channel selectivity : 73 dB (Wide)/65 dB (Narrow)
- Audio output power : 4.0 W typ. at 10% distortion with a 4 Ω load

**All stated specifications are subject to change without notice or obligation.**

## ◆ Channel frequency list

CH	Freq.	CH	Freq.	CH	Freq.	CH	Freq.
1	476.425	11	476.675	21	476.925	31	477.175
2	476.450	12	476.700	22	476.950	32	477.200
3	476.475	13	476.725	23	476.975	33	477.225
4	476.500	14	476.750	24	477.000	34	477.250
5	476.525	15	476.775	25	477.025	35	477.275
6	476.550	16	476.800	26	477.050	36	477.300
7	476.575	17	476.825	27	477.075	37	477.325
8	476.600	18	476.850	28	477.100	38	477.350
9	476.625	19	476.875	29	477.125	39	477.375
10	476.650	20	476.900	30	477.150	40	477.400

## UT-108 DTMF DECODER UNIT

Provides pager and code squelch capabilities.

## UT-109/UT-110 VOICE SCRAMBLER UNITS

- UT-109: Non-rolling type (max. 32 codes)
- UT-110: Rolling type (max. 1020 codes)



UT-108

UT-109

UT-110

## SP-22 EXTERNAL SPEAKER



Compact and easy-to-install. Same as that supplied with some versions.  
Input impedance: 4  $\Omega$   
Max. input power: 5 W

## HM-100TN DTMF MICROPHONE

Hand microphone with a DTMF keypad.



## SM-25 DESKTOP MICROPHONE

For base station operation.  
Monitor switch is equipped.



## OPC-617 ACC CABLE

Provides external terminal connection.



**Count on us!**

A-6287D-1AU  
Printed in Japan  
© 2003 Icom Inc.

**Icom Inc.**

1-1-32 Kamiminami, Hirano-ku, Osaka 547-0003 Japan